

1

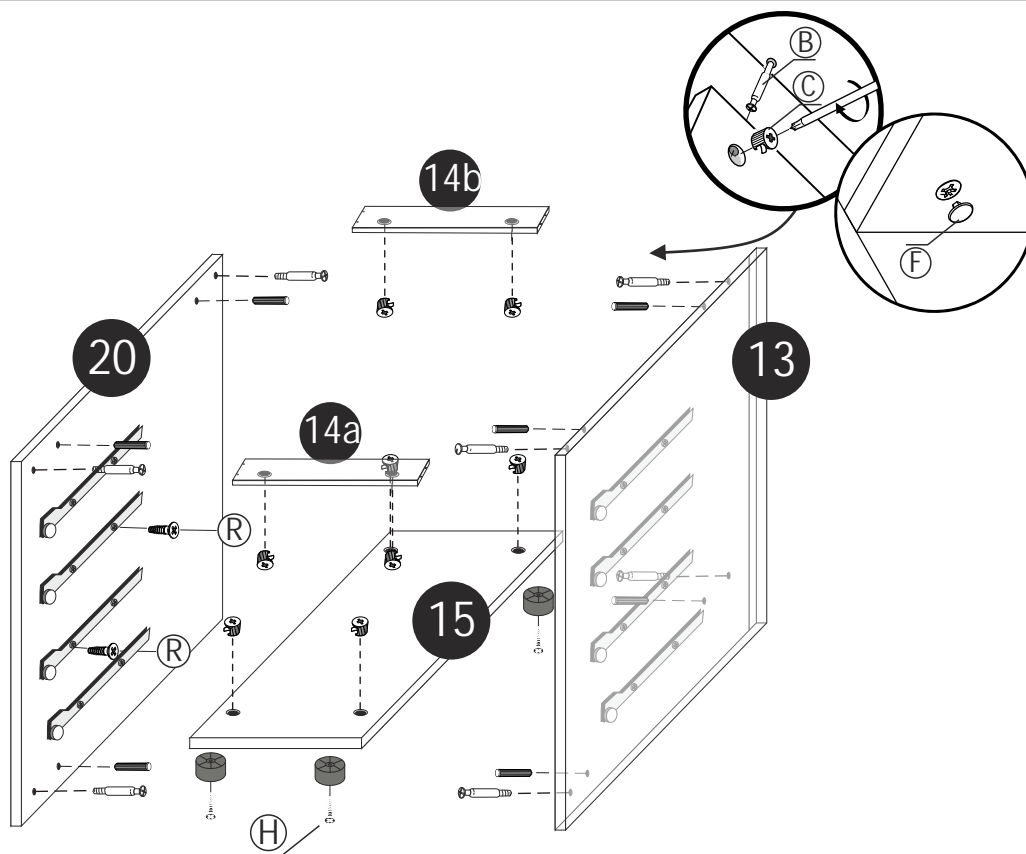

2

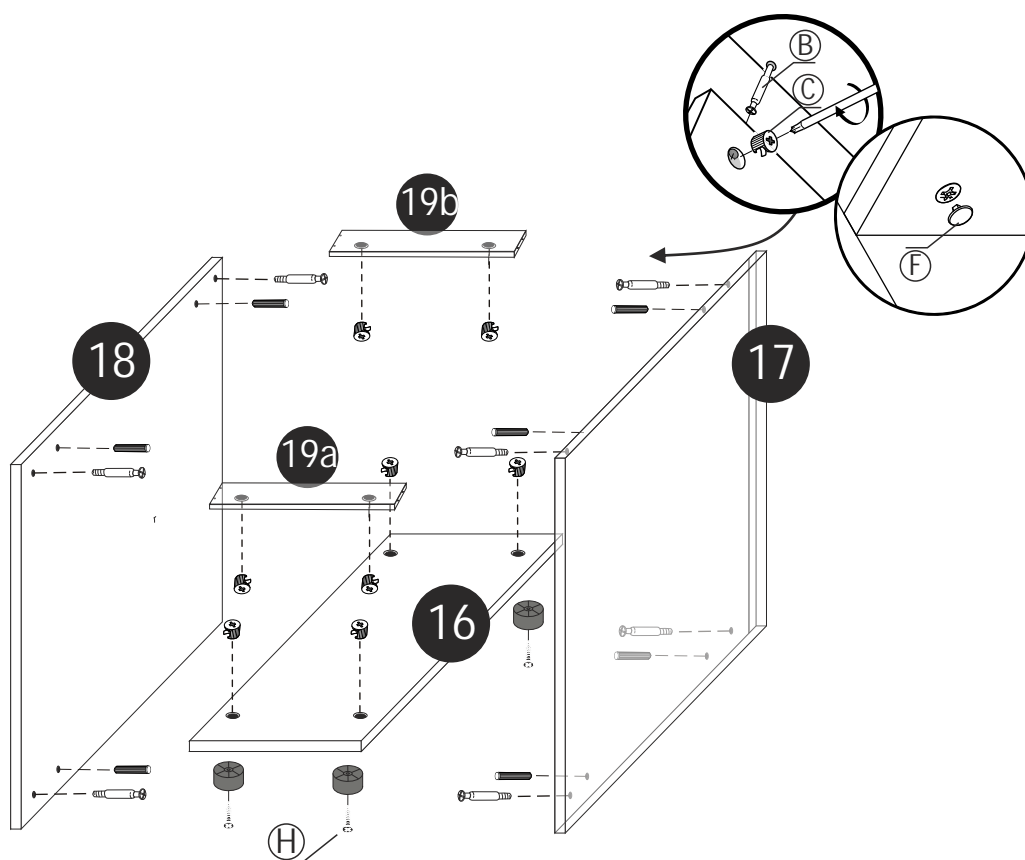

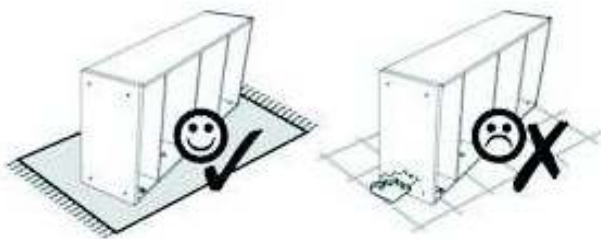



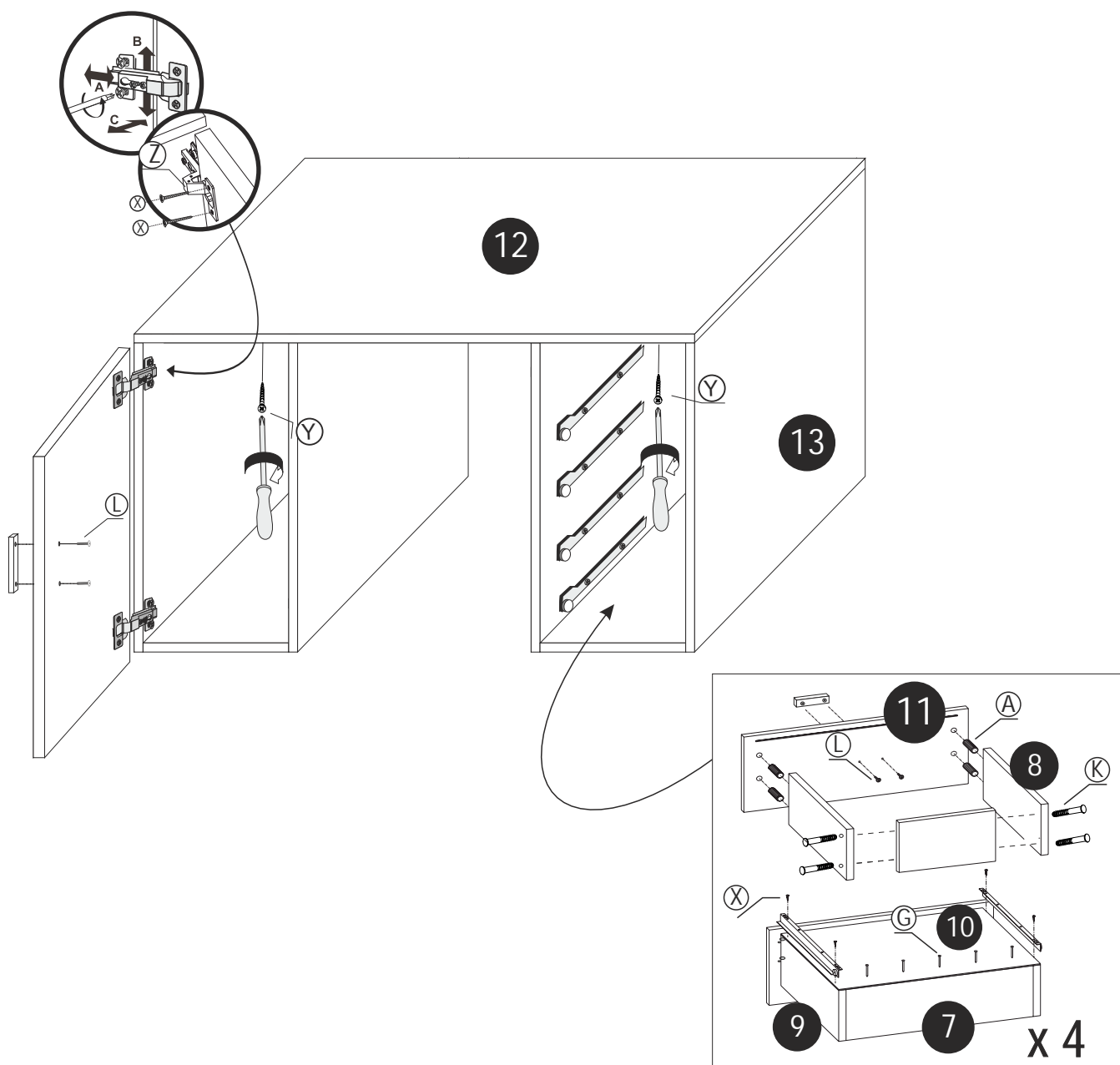

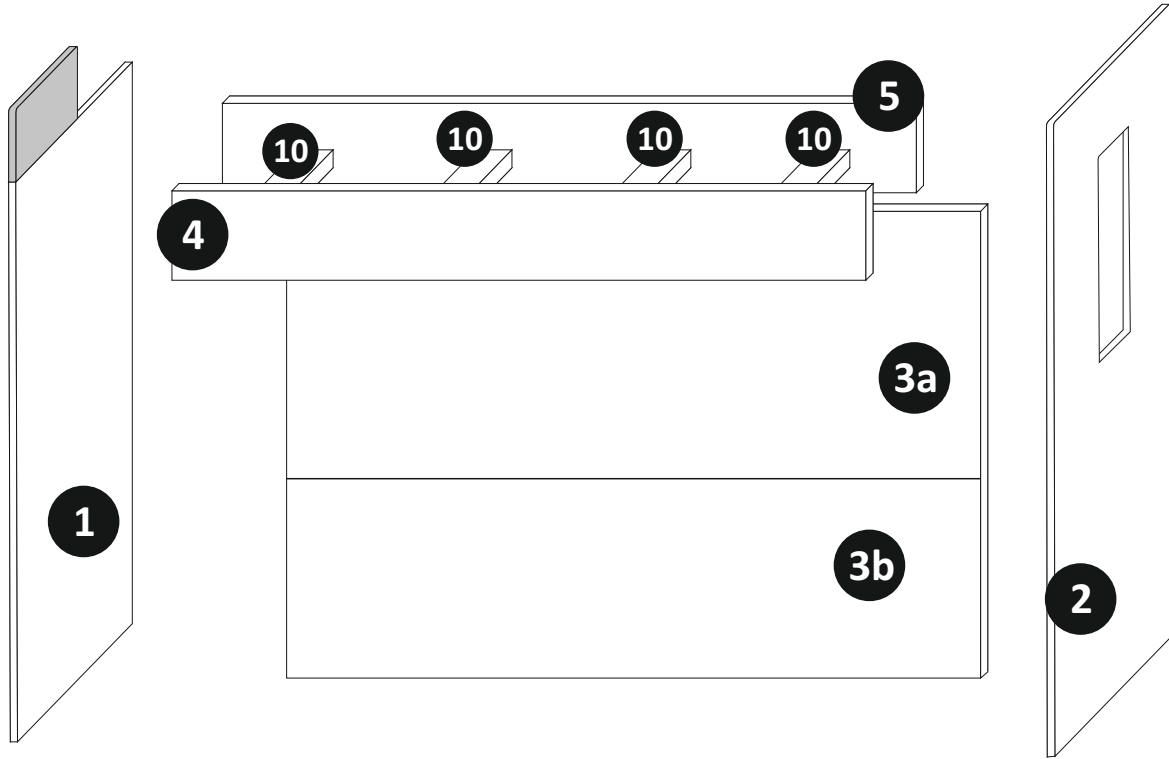
3



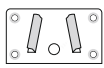
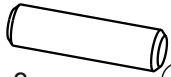

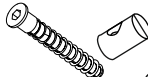
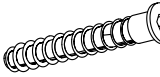
- | | | |
|------|---|-----|
| x 2 |  | (R) |
| x 8 |  | |
| x 8 |  | |
| x 8 |  | (A) |
| x 56 |  | (X) |
| x 8 |  | (E) |
| x 8 |  | (D) |

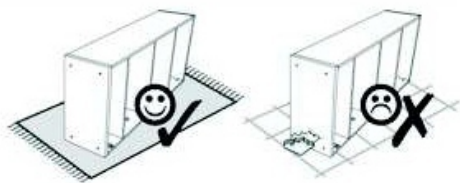

1

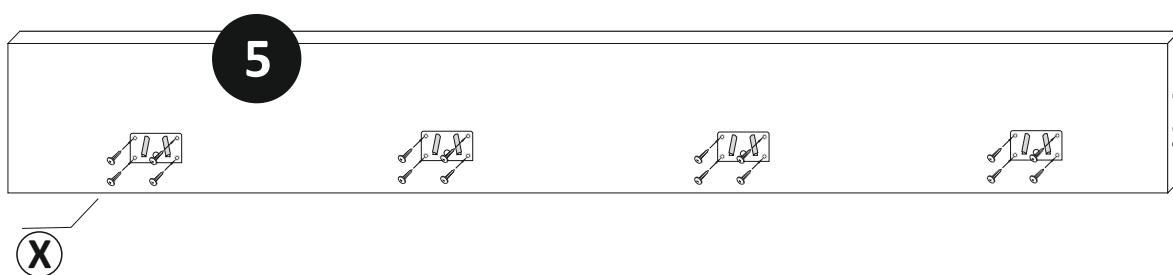

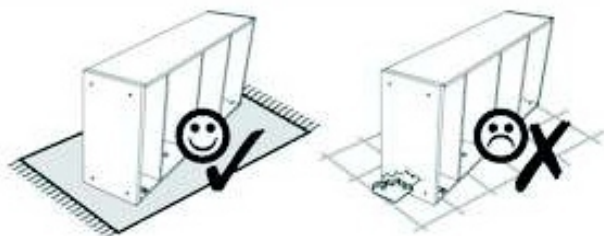

3

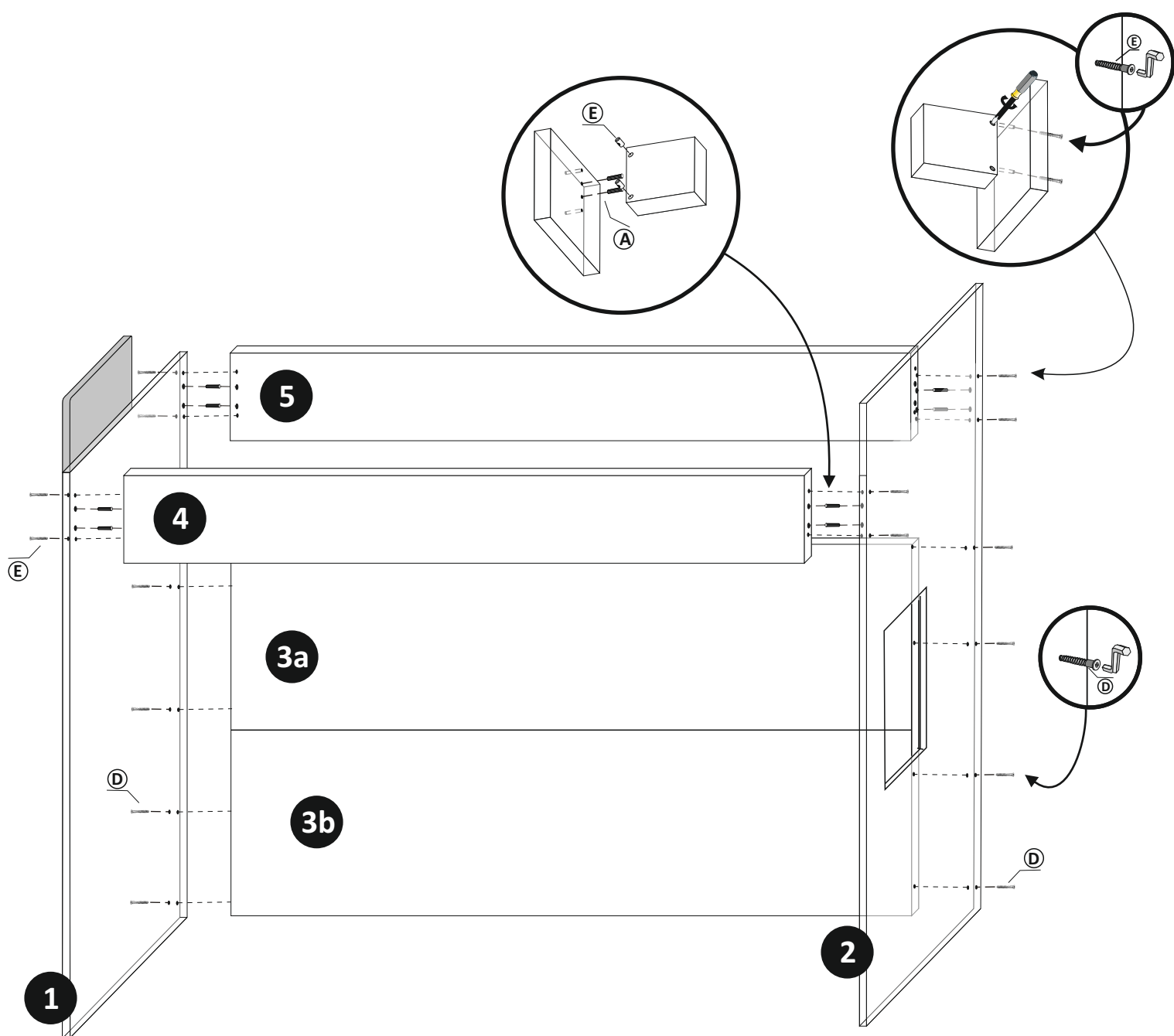

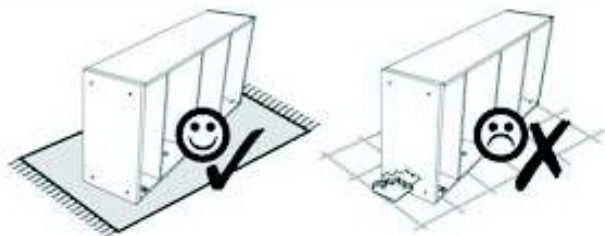

4

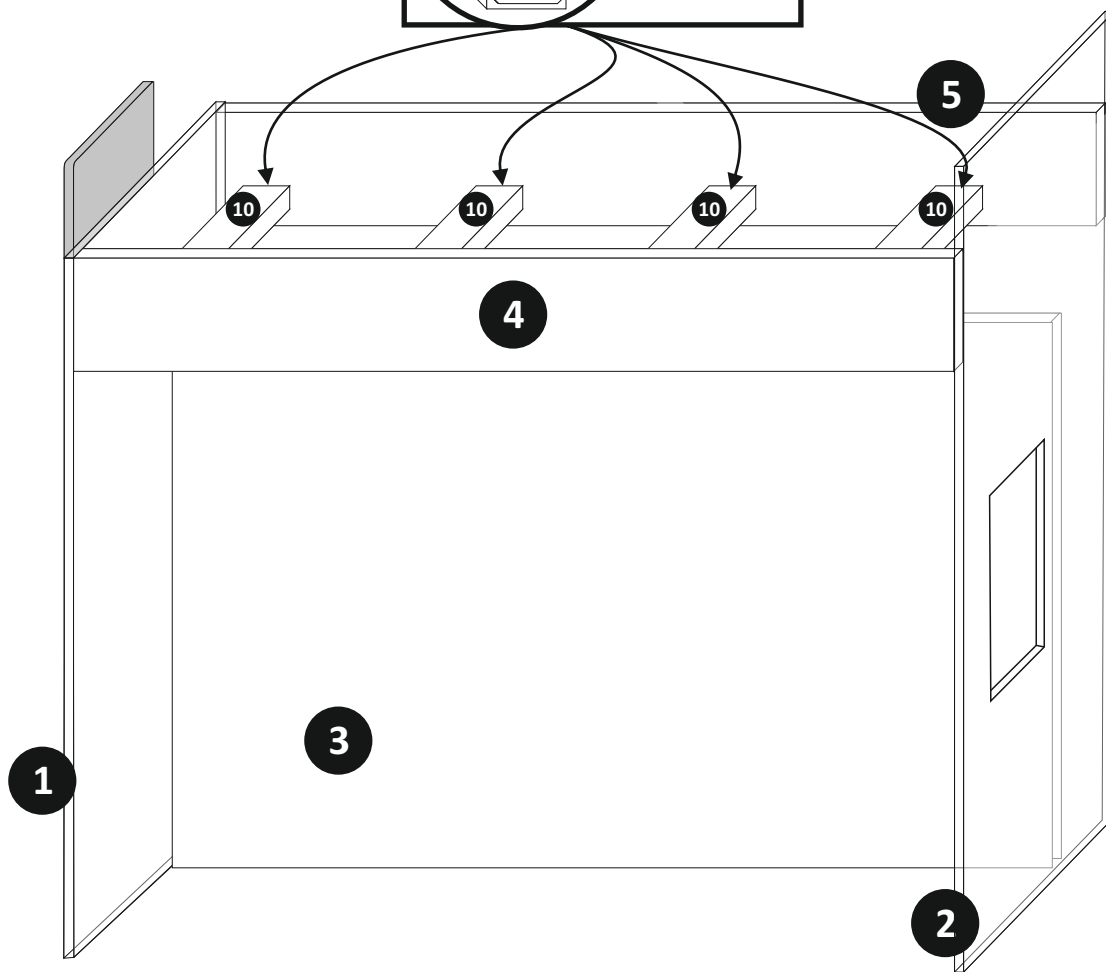
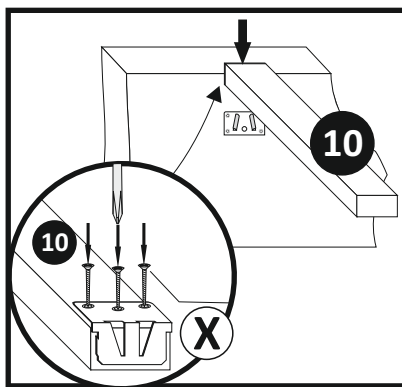

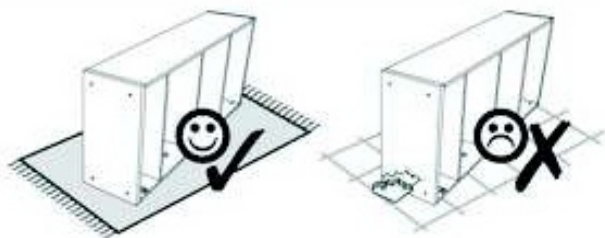

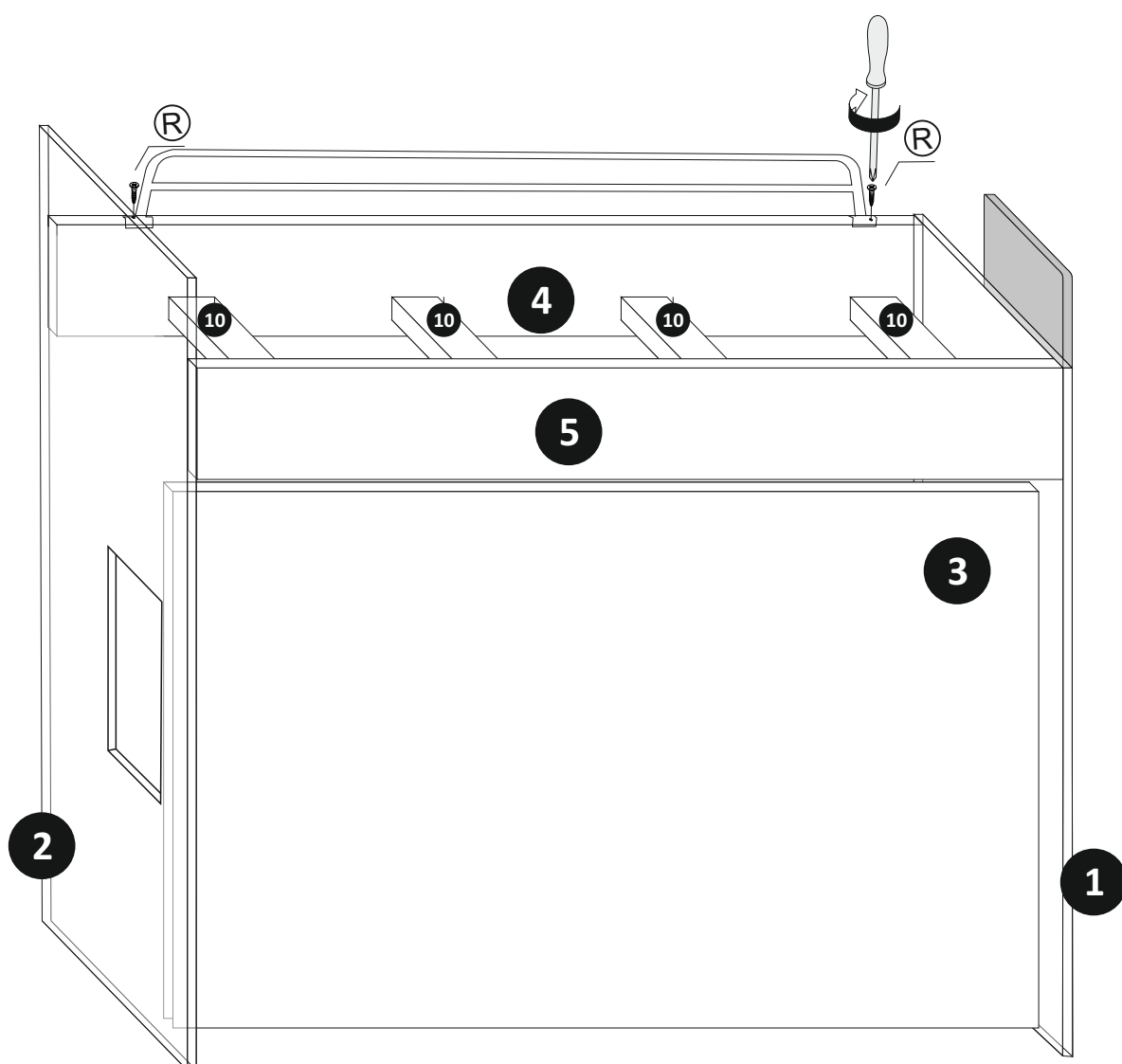

5

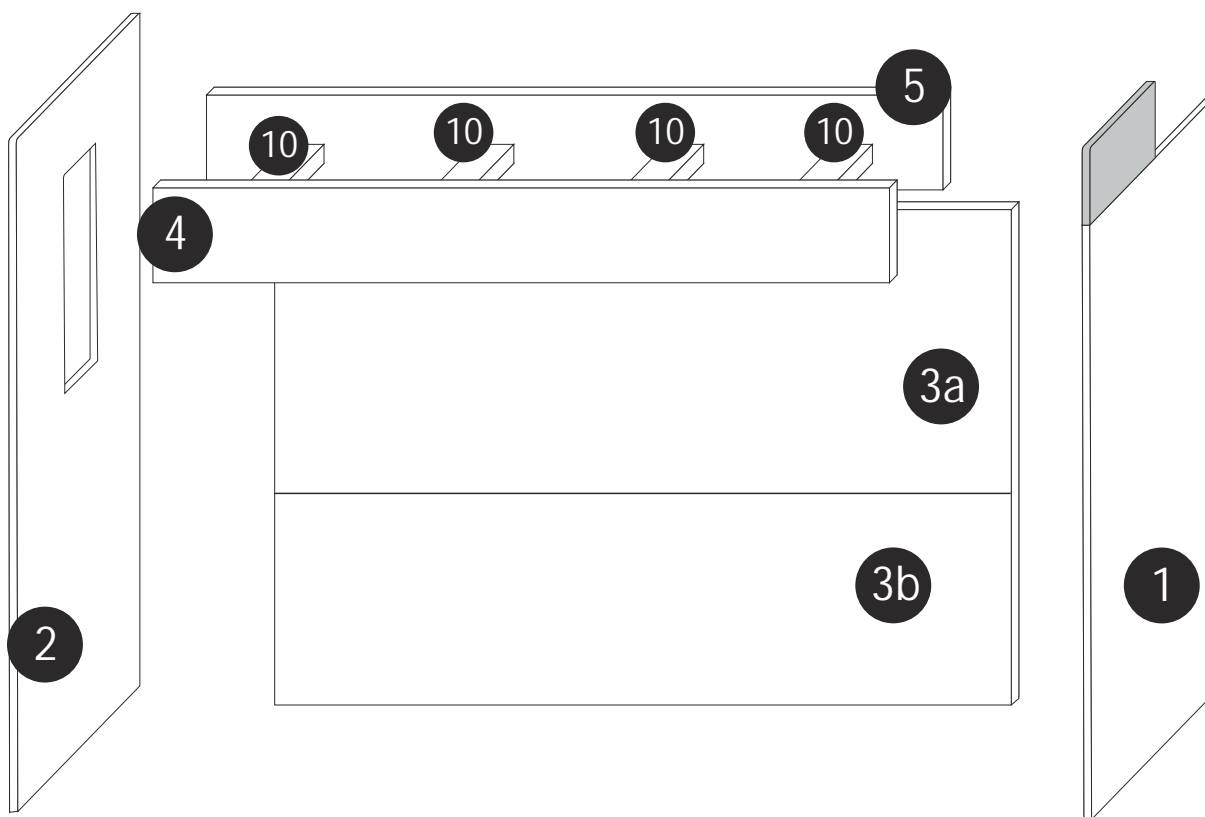

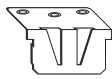

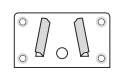
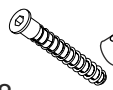
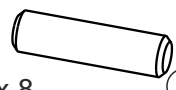
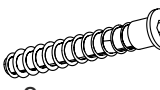
- | | | | |
|--|--|--|---|
| <p>4x20
x 2</p>  <p>(R)</p> | <p>x 8</p>  <p>4x16
x 56</p>  <p>(X)</p> | <p>x 8</p>  <p>x 8</p>  <p>(E)</p> | <p>x 8</p>  <p>(A)</p> <p>x 8</p>  <p>(D)</p> |
|--|--|--|---|

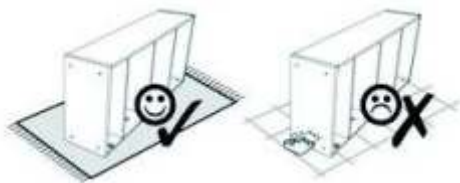

1

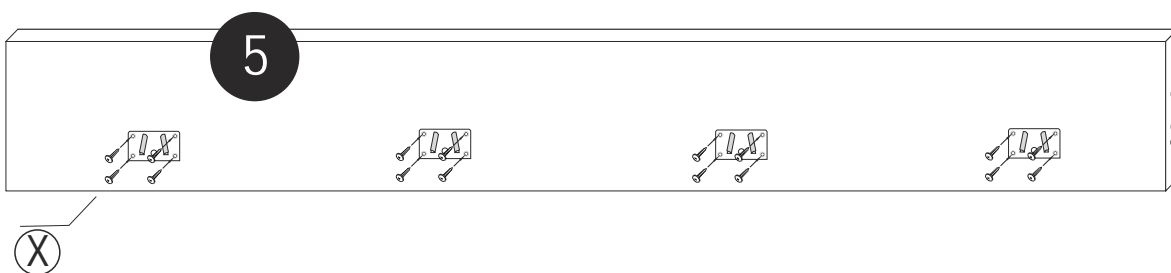

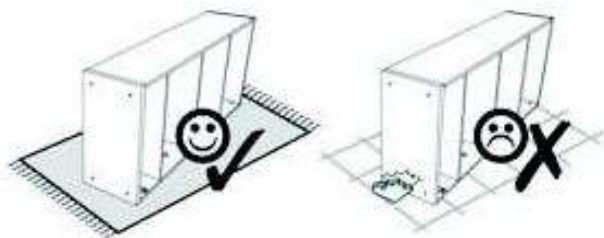

3

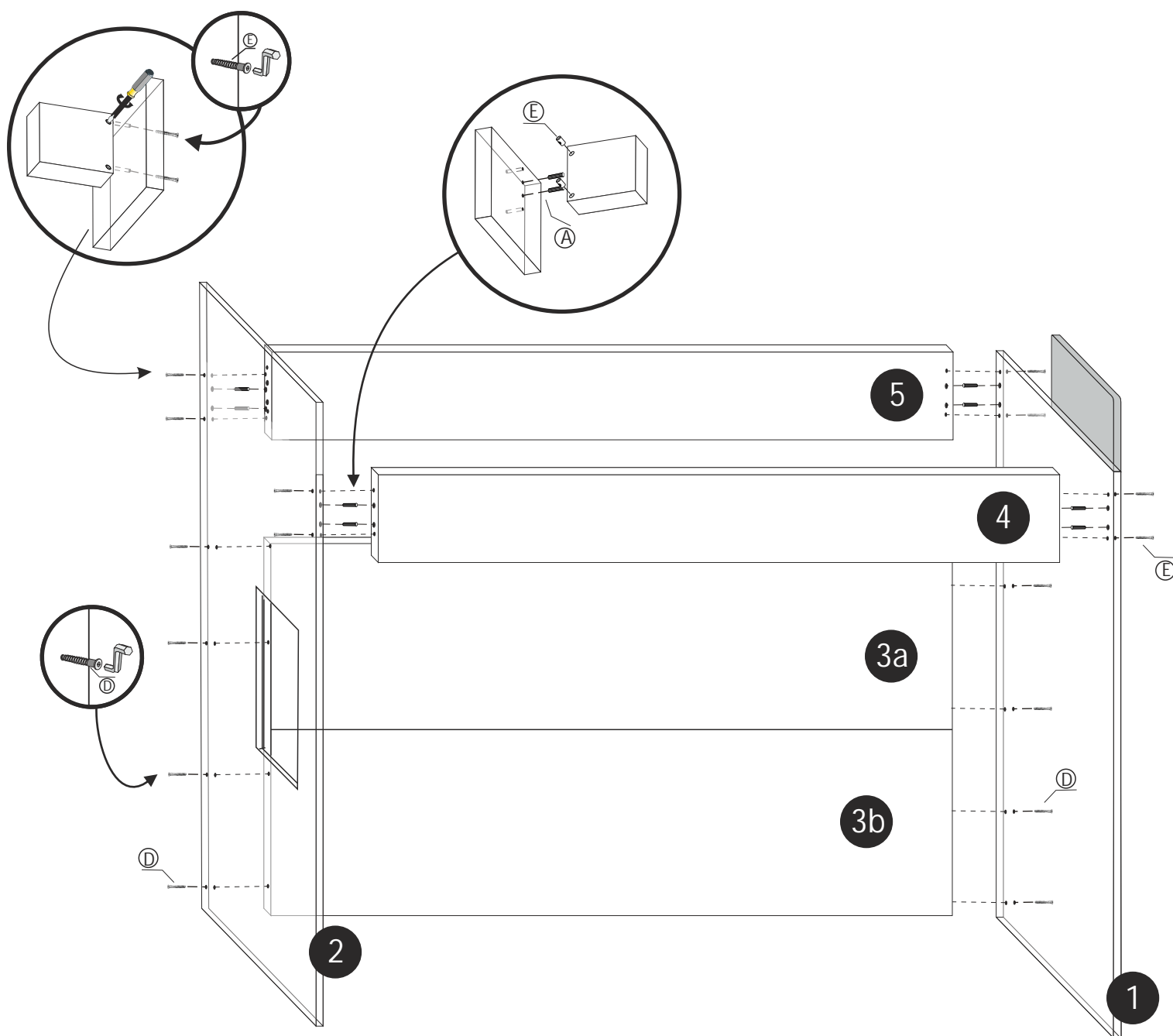

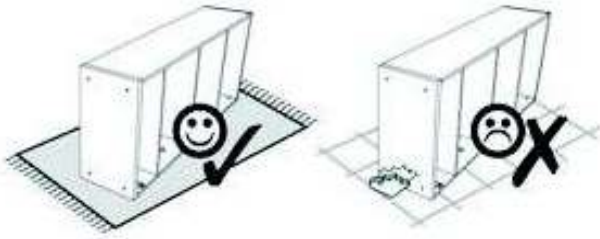

4

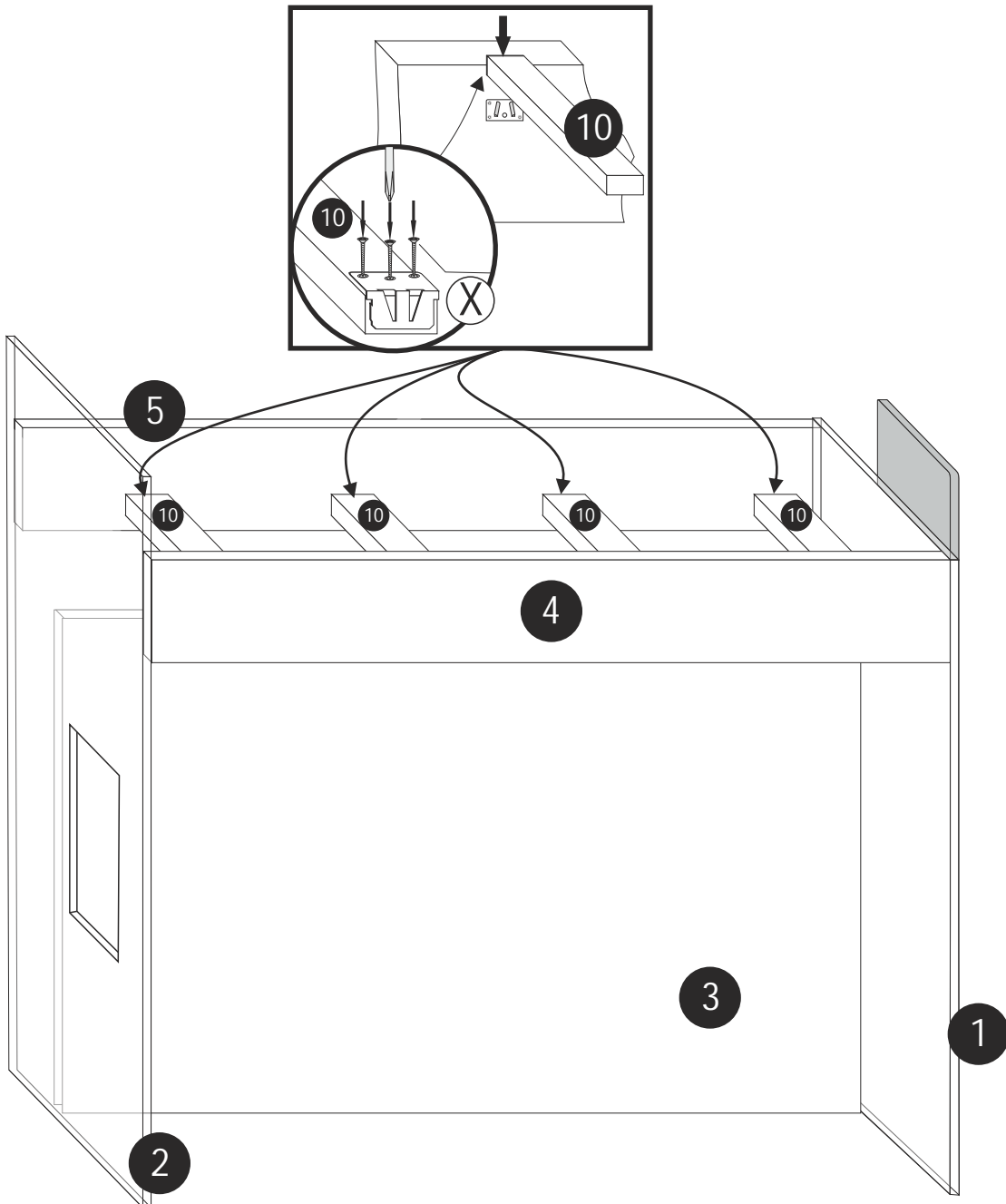

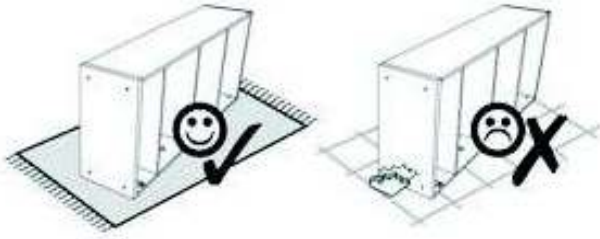



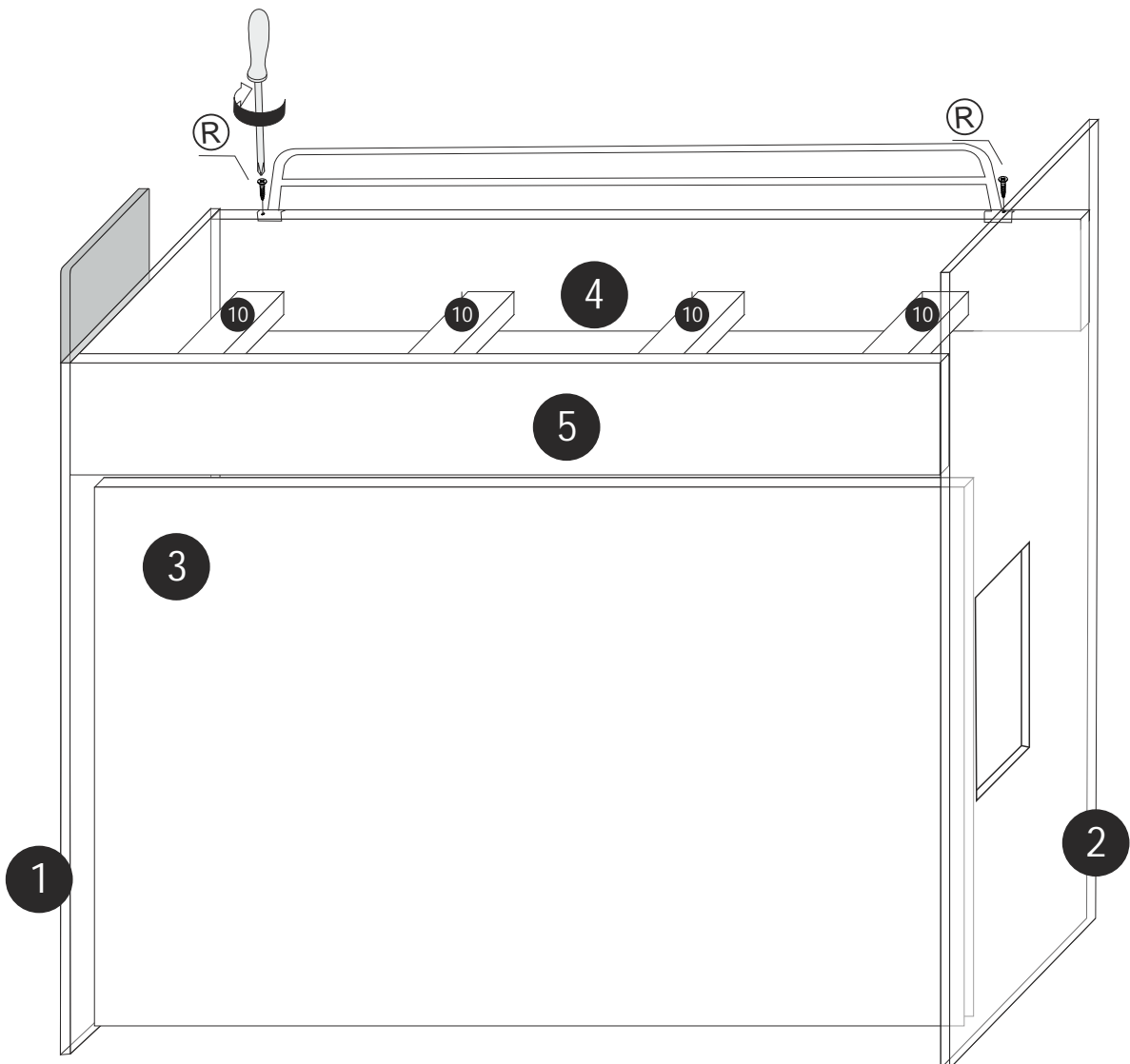

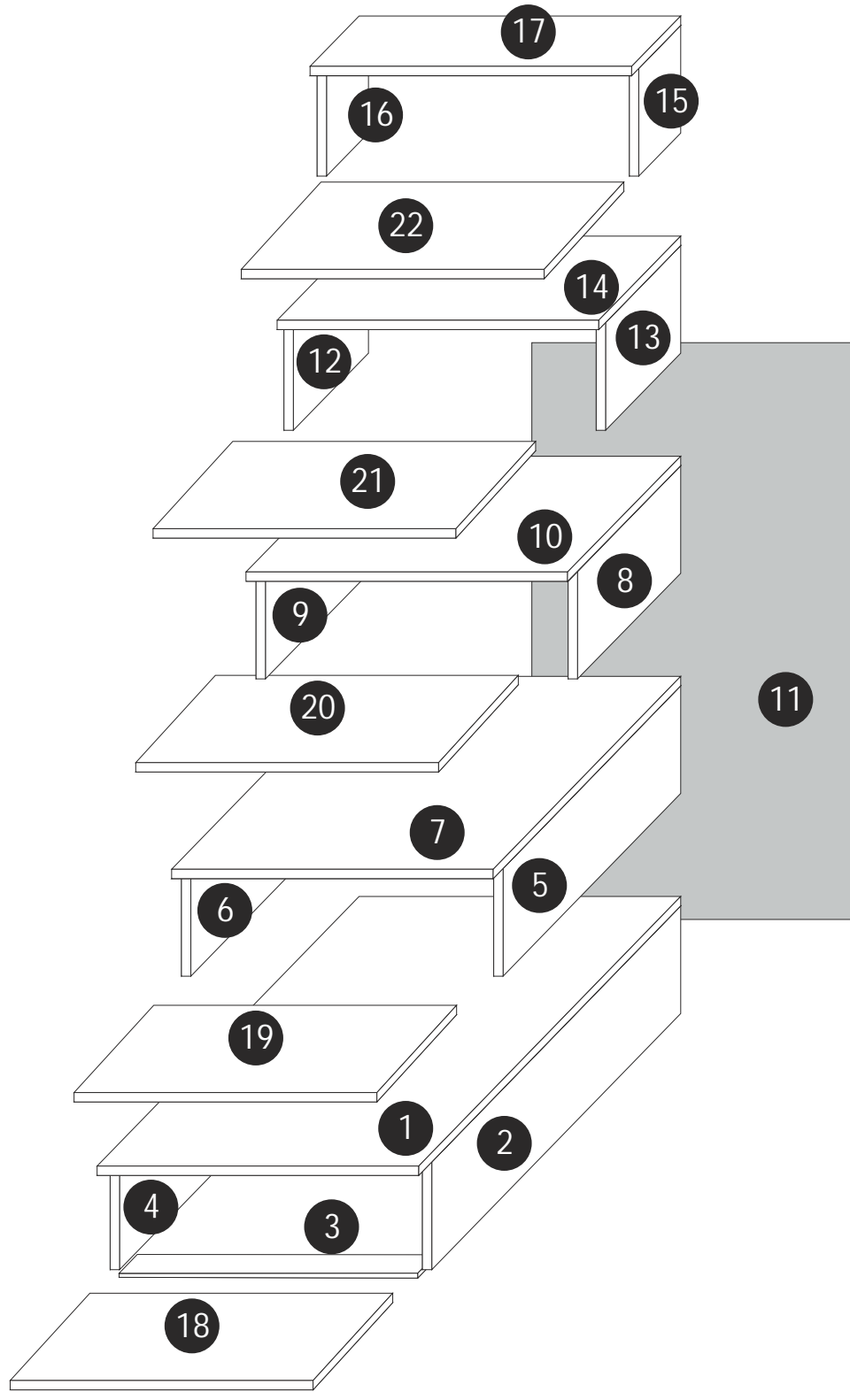

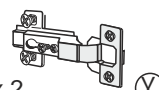
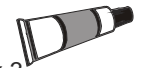

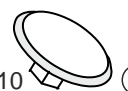
5

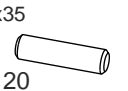
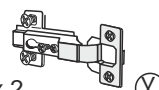
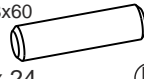



- | | | | | | |
|--|---|---|--|---|---|
| 
x 2 | 
x 3 | 
x 50 | 
x 10 | 
x 10 | 
8x35
x 20 |
| 
x 2 | 
8x60
x 24 | 
x 2 | 
x 8 | 
4x16
x 20 | 
x 10 |



1

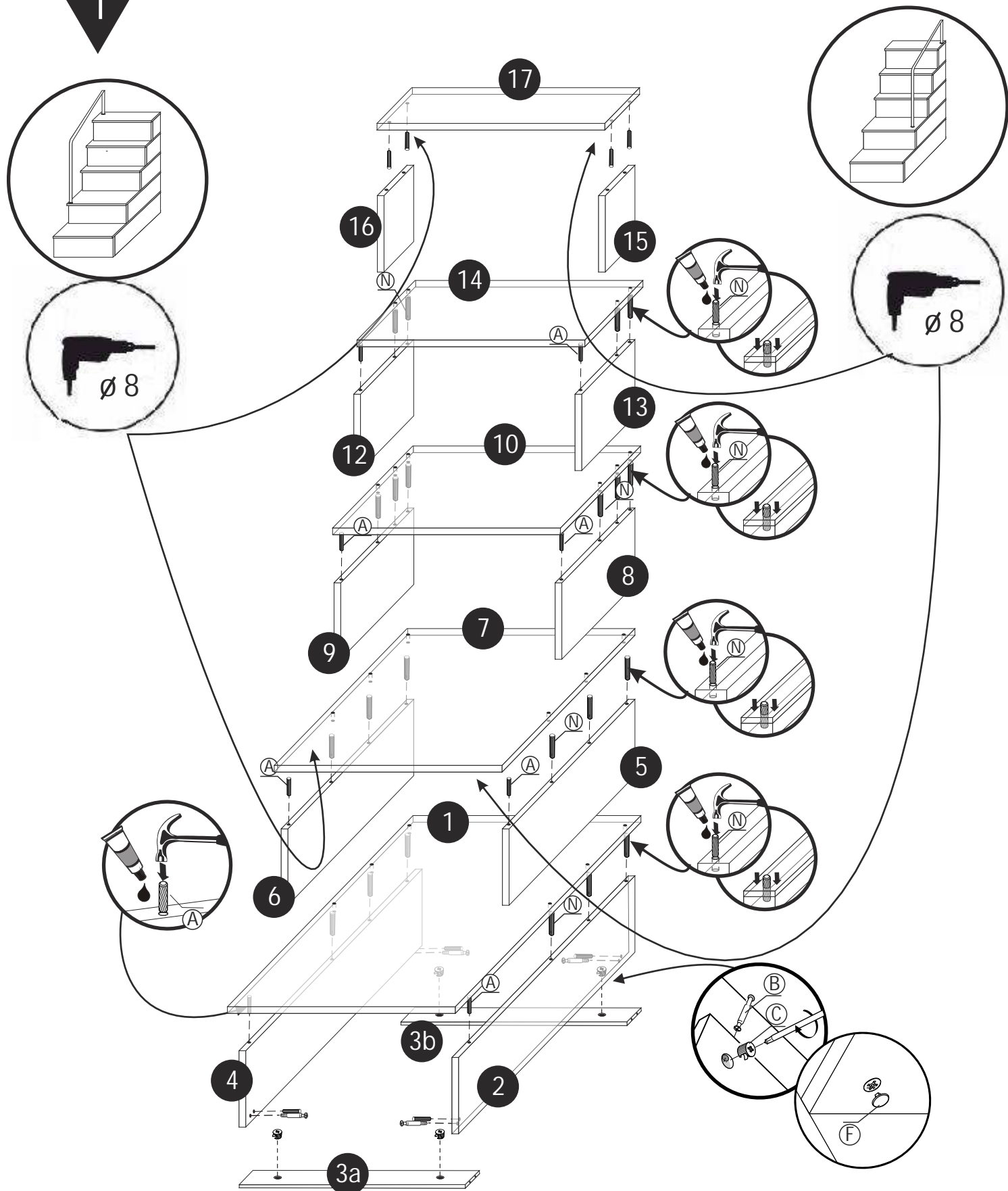

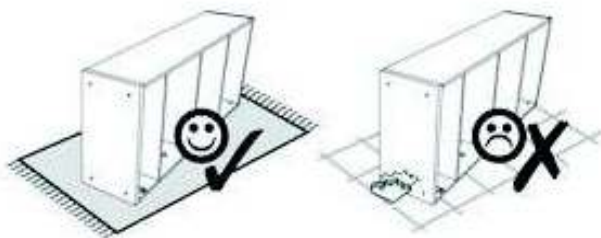

2

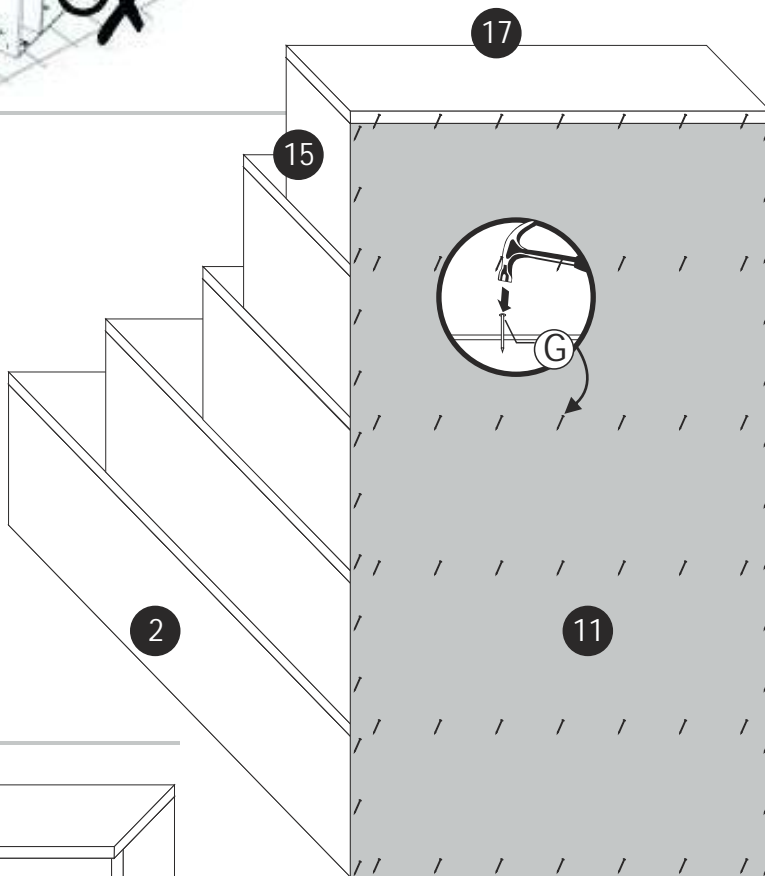

3

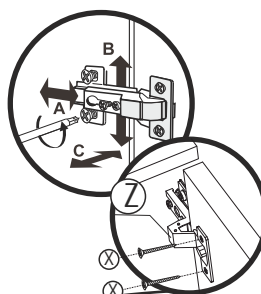
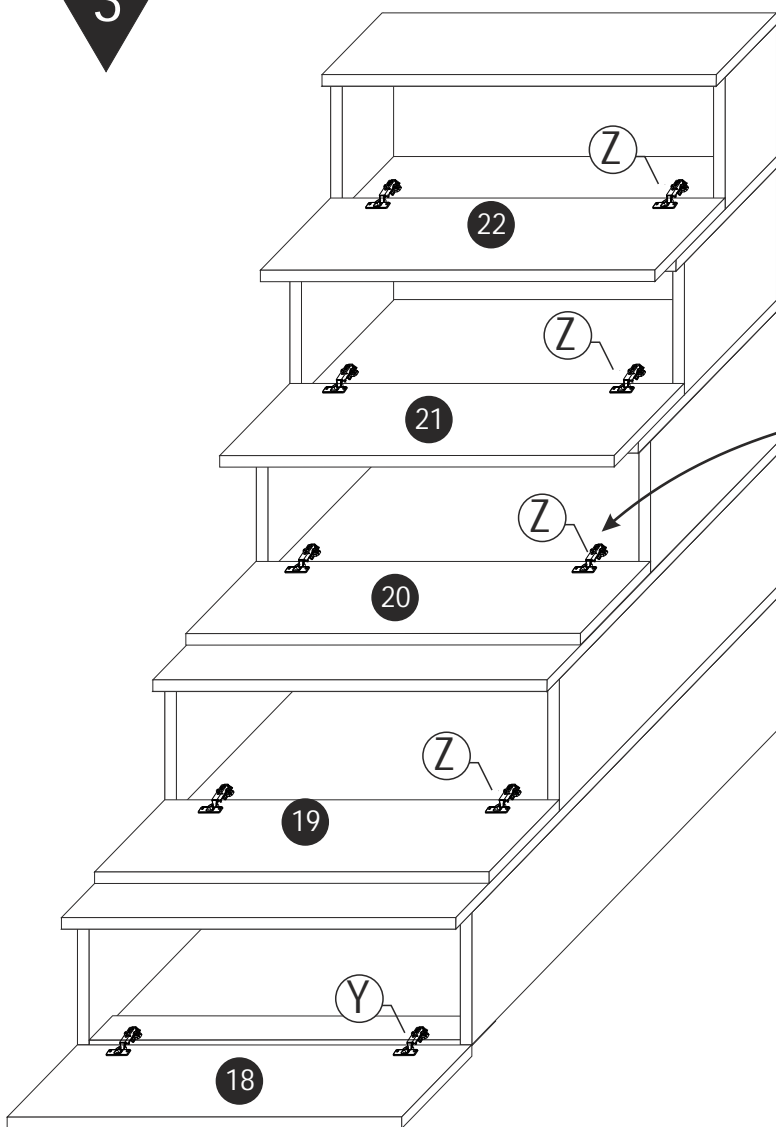

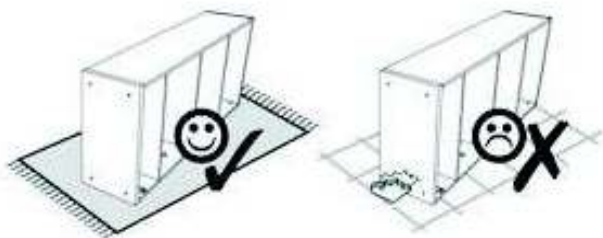

3

